

FLENDER N-EUPEX® and FLENDER N-EUPEX-DS® couplings

Types H and
HDS

Operating instructions
BA 3101 EN 09/2011



FLENDER couplings

SIEMENS



FLENDER N-EUPEX[®] and FLENDER N-EUPEX-DS[®] couplings

Types H and
HDS

Operating instructions

Translation of the original operating instructions

Technical data **1**

General notes **2**

Fitting **3**

**Start-up
and operation** **4**

**Faults, causes
and remedy** **5**

**Maintenance
and repair** **6**

Stocking spare parts **7**

Declarations **8**

Notes and symbols in these operating instructions

Note: The term "Operating instructions" will in the following also be shortened to "instructions" or "manual".

Legal notes

Warning-note concept

This manual comprises notes which must be observed for your personal safety and for preventing material damage. Notes for your personal safety are marked with a warning triangle or an "Ex" symbol (when applying Directive 94/9/EC), those only for preventing material damage with a "STOP" sign.



WARNING! Imminent explosion!

The notes indicated by this symbol are given to prevent **explosion damage**.
Disregarding these notes may result in serious injury or death.



WARNING! Imminent personal injury!

The notes indicated by this symbol are given to prevent **personal injury**.
Disregarding these notes may result in serious injury or death.



WARNING! Imminent damage to the product!

The notes indicated by this symbol are given to prevent **damage to the product**.
Disregarding these notes may result in material damage.



NOTE!

The notes indicated by this symbol must be treated as general **operating information**.
Disregarding these notes may result in undesirable results or conditions.



WARNING! Hot surfaces!

The notes indicated by this symbol are made to prevent **risk of burns due to hot surfaces**
and must always be observed.
Disregarding these notes may result in light or serious injury.

Where there is more than one hazard, the warning note for whichever hazard is the most serious is always used. If in a warning note a warning triangle is used to warn of possible personal injury, a warning of material damage may be added to the same warning note.

Qualified personnel

The product or system to which these instructions relate may be handled only by persons qualified for the work concerned and in accordance with the instructions relating to the work concerned, particularly the safety and warning notes contained in those instructions. Qualified personnel must be specially trained and have the experience necessary to recognise risks associated with these products or systems and to avoid possible hazards.

Intended use of Siemens products

Observe also the following:



Siemens products must be used only for the applications provided for in the catalogue and the relevant technical documentation. If products and components of other makes are used, they must be recommended or approved by Siemens. The faultfree, safe operation of the products calls for proper transport, proper storage, erection, assembly, installation, start-up, operation and maintenance. The permissible ambient conditions must be adhered to. Notes in the relevant documentations must be observed.

Trademarks

All designations indicated with the registered industrial property mark ® are registered trademarks of Siemens AG. Other designations used in these instructions may be trademarks the use of which by third parties for their own purposes may infringe holders' rights.

Exclusion of liability

We have checked the content of the instructions for compliance with the hard- and software described. Nevertheless, variances may occur, and so we can offer no warranty for complete agreement. The information given in these instructions is regularly checked, and any necessary corrections are included in subsequent editions.

Note on the EC Machinery Directive 2006/42/EC

Siemens couplings in the "FLENDER couplings" product range must be treated as "components" in the sense of the EC Machinery Directive 2006/42/EC.

Therefore, Siemens needs not issue a declaration of incorporation.

Information on safe fitting, safe startup and safe operation can be found in this instruction manual; in addition the "warning-note concept" therein must be observed.

Contents

1.	Technical data	6
1.1	Speeds, geometric data and weights	6
1.2	Flexible elements (12)	8
2.	Notes	9
2.1	Safety instructions and general notes	9
2.2	Marking of the coupling parts for use in potentially explosive zones	10
2.3	Service conditions	10
3.	Fitting	11
3.1	Machining the finished bore	11
3.2	Machining the parallel keyway	11
3.3	Axial fastening	12
3.4	Balancing after machining the finished bore	13
3.5	Installation of the coupling parts	13
3.6	Possible misalignments	14
3.6.1	Axial misalignment	14
3.6.2	Angular misalignment	14
3.6.3	Radial misalignment	14
3.7	Alignment	15
3.8	Shaft-displacement values during operation	15
3.9	Assignment of the tightening torques and wrench widths	16
4.	Start-up and operation	16
5.	Faults, causes and remedy	17
5.1	Possible cause of fault	17
5.2	Incorrect use	17
5.2.1	Frequent faults when selecting the coupling and/or coupling size	17
5.2.2	Frequent faults when fitting the coupling	17
5.2.3	Frequent faults in maintenance	18
6.	Maintenance and repair	18
6.1	Maintenance interval	18
6.2	Replacement of wearing parts	19
6.3	Demounting the coupling parts in case of shaft-hub connection with parallel key	19
7.	Stocking spare parts	20
7.1	Spare parts	20
8.	Declarations	21
8.1	EC declaration of conformity	21

1. Technical data

The instructions describe the coupling in horizontal mounting position with shaft-to-hub connection by cylindrical or conical bore with parallel key. If a vertical or inclined arrangement or other shaft-to-hub connections, such as shrink fit or splines to DIN 5480, are to be used, Siemens must be consulted.

The coupling described below may be used in potentially explosive areas. The couplings must have a CE marking (for marking, see item 2.2).



Couplings which do not have a CE marking, must not be used in potentially explosive areas.

If a dimensioned drawing has been made out for the coupling, the data in this drawing must be given priority. The dimensioned drawing including any other documents should be made available to the user of the system.

For part numbers and part designations, see the corresponding spare-parts drawing in section 7 or the dimensioned drawing.

1.1 Speeds, geometric data and weights

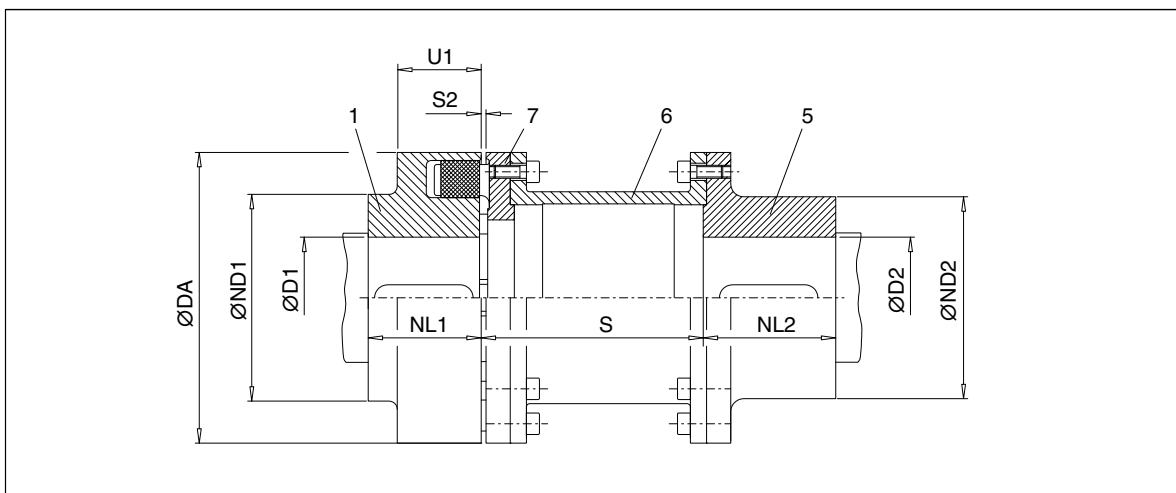

Fig. 1: Type H

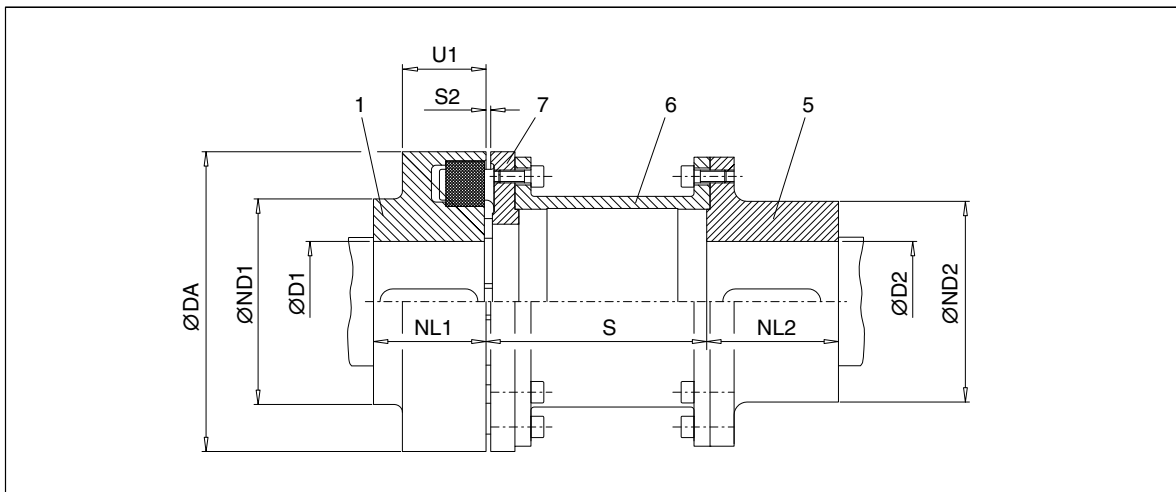

Fig. 2: Type HDS

Table 1: Speeds, geometric data and weights of types H and HDS

Size		Speed n _{max.} 1/min	Part 1 Type H					Part 1 Type HDS					Types H and HDS					Weight 2) m	
H	HDS		DA mm	D1 1) mm	ND1 mm	NL1 mm	U1 mm	DA mm	D1 1) mm	ND1 mm	NL1 mm	U1 mm	D2 mm	ND2 mm	NL2 mm	S2 + 1 mm	S + 1 mm	H kg	HDS kg
80	88	6000	80	30	80	30	30	88	30	88	30	30	32	55	45	5	100	2.6	2.8
																	140	2.7	2.9
95	103	5500	95	42	76	35	30	103	42	76	35	30	42	70	45	5	100	3.5	4
																	140	3.8	4.3
110	118	5300	110	48	86	40	34	118	48	86	40	34	48	80	50	5	100	5.2	5.3
																	140	5.4	5.7
125	135	5100	125	55	100	50	36	135	55	100	50	36	55	90	50	5	100	7.2	7.6
																	140	7.7	8.1
140	152	4900	140	60	100	55	34	152	60	108	55	36	60	100	65	5	100	10	11.2
																	140	10.5	11.7
160	172	4250	160	65	108	60	39	172	65	118	60	41	65	108	70	6	100	13	14.3
																	140	13.7	15
180	194	3800	180	75	125	70	42	194	75	135	70	44	75	125	80	6	140	18.5	21
																	180	19.4	22
200	218	3400	200	85	140	80	47	218	85	150	80	47	85	140	90	6	140	25.6	30
																	180	26.5	31
225	245	3000	225	90	150	90	52	245	90	150	90	52	90	150	100	6	140	34	35
																	180	35	36
250	272	2750	250	100	165	100	60	272	100	165	100	60	100	165	110	8	180	48	51
																	200	50	52
280	305	2450	280	110	180	110	65	305	110	180	110	65	110	180	120	8	250	70	74
																	250	70	74
315	340	2150	315	100	165	125	70	340	120	200	125	70	120	200	140	8	250	98	105
				120	200												100		
350	380	2000	350	110	180	140	74	380	140	230	140	74	140	230	150	8	250	120	130
				140	230												125		
400	430	1700	400	120	200	160	78	430	150	250	160	78	150	250	180	8	250	195	205
				150	250												200		
440	472	1550	440	130	215	180	86	472	160	265	180	86	160	265	180	10	250	225	235
				160	265												230		

1) Maximum bore with keyway to DIN 6885/1.

2) Weights apply to maximum bores.

1.2 Flexible elements (12)

- Flexible elements may be stored for up to 5 years.
- Flexible elements must be protected against direct sunlight, artificial light with a high ultraviolet content and extreme temperatures.
- Flexible elements must not come into contact with aggressive media.
- Flexible elements must not be heated up to impermissible temperatures during fitting work (see table 2).
- Flexible elements must be replaced in sets; only identical flexible elements may be used in one coupling.

Table 2: N-EUPEX flexible elements

Material	Hardness	Remark	Mark	Temperature range
NBR	80 Shore A	Standard	black flexible elements with blue stripes	- 30 °C to + 80 °C
NBR	65 Shore A	Special, soft, shift of rotary resonance speed, nominal torque reduced	black flexible elements with green stripe	- 30 °C to + 80 °C
NBR	90 Shore A	Special, hard, shift of rotary resonance speed	black flexible elements with magenta stripe	- 30 °C to + 80 °C
NBR	80 Shore A	Special, increased (low-backlash)	black flexible elements with yellow stripe	- 30 °C to + 80 °C
NBR	65 Shore A	Special, increased (low-backlash), shift of rotary resonance speed, nominal torque reduced	black flexible elements with white stripe	- 30 °C to + 80 °C
NR	80 Shore A	Special, use at low temperature	black flexible elements with orange stripe	- 50 °C to + 50 °C
HNBR	80 Shore A	Special, use at high temperature	black flexible elements with red stripe	- 10 °C to + 100 °C
NBR	80 Shore A	Special, electrically insulating	green flexible elements	- 30 °C to + 80 °C



Electrically insulation flexible elements (green) are approved for explosion groups IIA and IIB.

High-temperature flexible elements (red marking) are not approved for use in potentially explosive areas.

Table 3: N-EUPEX-DS flexible elements

Material	Hardness	Remark	Mark	Temperature range
NBR	80/90 Shore A	Standard, 2-components, sizes 66 to 272	black flexible elements	- 30 °C to + 80 °C
NBR	90 Shore A	Standard, sizes 305 to 556	black flexible elements	- 30 °C to + 80 °C
PU	95 Shore A	Special, electrically insulating	blue / green flexible elements	- 30 °C to + 50 °C



Electrically insulation flexible elements (blue / green) are approved for explosion groups IIA and IIB.

2. Notes

2.1 Safety instructions and general notes



All persons involved in the installation, operation, maintenance and repair of the coupling or clutch must have read and understood these instructions and must comply with them at all times. Disregarding these instructions may cause damage to the product and material and/or injury to persons. Damage caused by disregard of these instructions will result in exclusion of liability.

During transport, installation, dismantling, operation and maintenance of the unit, the relevant safety and environmental regulations must be complied with at all times.



Lifting gears and load equipment for handling the components must be suitable for the weight of the coupling.

Depending on national regulations, coupling and clutch components may have to be disposed of separately or separated for recycling.

The coupling must be stored in a dry environment. Adequate preservation must be carried out.

Operators and users must not make any changes to the coupling themselves over and above the treatment specified in these instructions.



If there is any visible damage the coupling or clutch must not be fitted or put into operation!

The coupling must not be operated unless housed in a suitable enclosure in accordance with the standards applying. This also applies to test runs and when checking the direction of rotation.

All work on the coupling must be carried out only when it is at a standstill. Secure the drive unit to prevent unintentional switch-on. A notice should be attached to the ON switch stating clearly that work is in progress.

In addition to any generally prescribed personal safety equipment (such as safety shoes, safety clothing, helmet) **suitable safety gloves** and **suitable safety glasses** must be worn when handling the coupling or clutch!

Only spare parts made by the manufacturer Siemens must be used.





Any enquiries should be addressed to:

Siemens AG
Schlavenhorst 100
46395 Bocholt

Tel.: +49 (0)2871 / 92-0
Fax: +49 (0)2871 / 92-2596

2.2 Marking of the coupling parts for use in potentially explosive zones

Couplings which are ordered in Atex configuration, have the following marking on the outer circumference of coupling part 1:

Siemens AG	 	II 2G T4 / T5 / T6 D120 °C
46393 Bocholt - Germany		(- 50 °C) - 30 °C ≤ T _a ≤ + 80 °C / + 50 °C / + 40 °C
FLENDER couplings N-EUPEX <year built>	 	I M2

Coupling part 2 or coupling part 4 bear the marking  .

The marking is in one or two lines.

If, in addition to the CE mark, the letter "U" together with the Siemens order number has been stamped on, the coupling part has been delivered by Siemens un- or prebored.



Siemens supplies unbored and prebored couplings with CE marking only under the condition that the customer assumes the responsibility and liability for correct refinishing in a declaration of exemption.

When using electrically insulating flexible elements, the marking of the explosion group IIA, IIB is added.

2.3 Service conditions

The coupling is suited for service conditions in accordance with Directive 94/9/EC:

- Equipment group II (use above ground) of categories 2 and 3 for areas where there are explosible gas, vapour, mist, air mixtures as well as for areas where dust can form explosible atmospheres.
- The permissible temperature classes and/or maximum surface temperatures are assigned as a function of the maximum ambient temperature occurring in the immediate vicinity of the coupling (see Table 4).

Table 4: Temperature classes

Ambient temperature	Temperature class	max. surface temperature
max. 80 °C	T4	< 108 °C
max. 50 °C	T5	< 80 °C
max. 40 °C	T6	< 68 °C

- Equipment group I (underground applications) of the category M2.
- Explosion group IIA or IIB in case of electrically insulating flexible elements.



If they are to be used below ground in potentially explosive areas the couplings must only be used with drive motors, which can be switched off on occurring of an explosible atmosphere.

The machines connected by the coupling must be earthed by an earth leakage resistance < 10⁶ Ω.

If lacquered couplings are used in potentially explosive areas, the requirements made of the conductivity of the lacquer and the limitation on the thickness of the lacquer applied must be observed in accordance with EN 13463-1. Where lacquer coatings have a thickness less than 200 µm, no electrostatic charge is to be expected.

3. Fitting

3.1 Machining the finished bore

Remove the flexible elements (12).

Depreserve and clean coupling parts (1; 5).

Clamp on surfaces marked with , and align.

Machine the finished bore, observe maximum bore described in section 1.

Check finished bore as described in section 3.

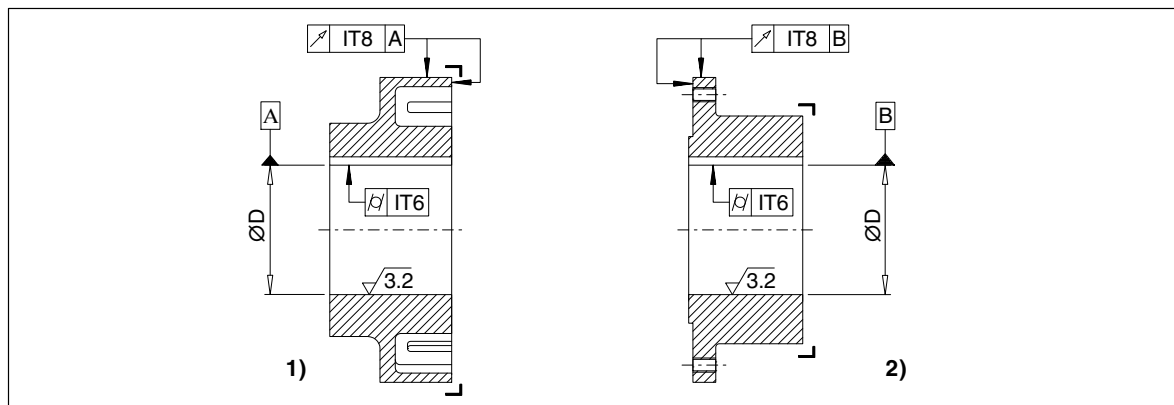

Fig. 3: Machining the finished bore

1) Coupling part 1

2) Coupling part 5

Table 5: Fit recommendation for bores with parallel-key connection

Description	Push fit not suitable for reversing operation		Press fit		Interference fit suitable for reversing operation		
	j6	h6	h6	k6	m6	n6	h6
Shaft tolerance							
Bore tolerance	H7	J7	K7	H7	H7	H7	M7

The fit assignment m6 / H7 is particularly suitable for many applications.



**Failure to observe these instructions may result in breakage of the coupling.
Danger from flying fragments!
The coupling may then become an explosion hazard.**

3.2 Machining the parallel keyway

- Parallel keyway to DIN 6885/1 ISO JS9 with usual operating conditions.
- Width of parallel keyway ISO P9 with reversing operation.

Arrangement of parallel keyway:

- with coupling part 1: centrally between the lands of the flexible elements
- with coupling part 1 DS: centrally between the pockets of the flexible elements
- with coupling part 5 / 5 DS: underneath a threaded bore

3.3 Axial fastening

Arrange set screw on the parallel keyway. An exception are the following coupling parts:

Part 1: Size 80 / 88 : Bore $D_1 \geq 25$ mm set screw displaced by 180° relative to the keyway.
 Size 95 / 103 : Bore $D_1 \geq 38$ mm set screw displaced by 180° relative to the keyway.

Position of the set screw to table 6.

Use threaded studs to DIN 916 with cup points as set screws (set-screw size to table 6).

The set screw is intended to fill out the screw thread as much as possible and must not project beyond the hub.

Alternatively use end plate; as regards recess contact Siemens.

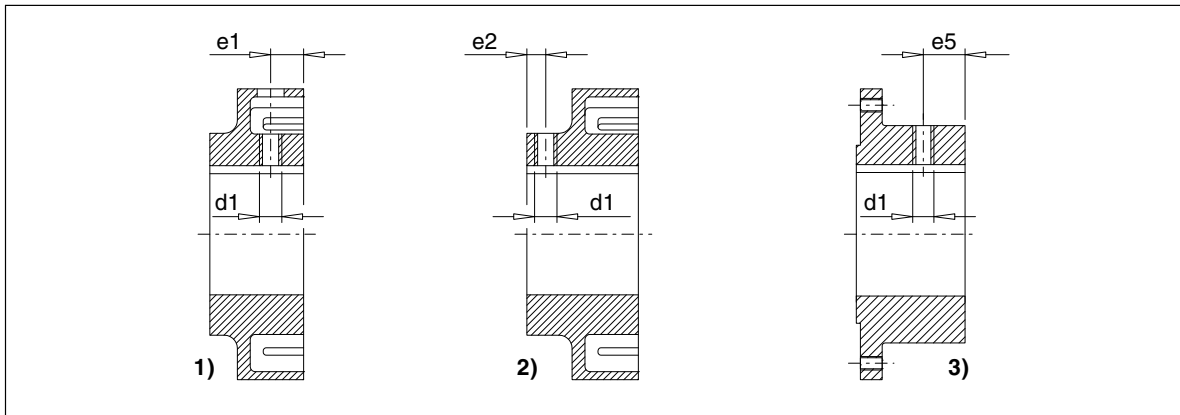

Fig. 4: Position of the set screw

- 1) Coupling part 1; position of the set screw up to size 125 / 135
- 2) Coupling part 1; position of the set screw from size 140 / 152 upwards
- 3) Coupling part 5

Table 6: Set-screw assignment, set-screw position and tightening torques

Size	80	95	110	125	140	160	180	200	225	250	280	315	350	400	440
	88	103	118	135	152	172	194	218	245	272					
d_1	M6	M6	M6	M8	M8	M10	M12	M12	M12	M16	M16	M16	M20	M20	M24
e_1	11	15	18	20	-	-	-	-	-	-	-	-	-	-	-
e_2	-	-	-	-	13	13	16	20	22	24	28	35	40	50	60
e_5	15	20	25	25	30	35	40	45	50	55	60	65	70	80	90
1)	4	4	4	8	8	15	25	25	25	70	70	70	130	130	230

1) Tightening torques of the set screws in Nm

Tightening torques apply to bolts with untreated surfaces which are not or only lightly oiled (coefficient of friction $\mu = 0.14$). The use of lubricant paint or lubricant, which affects the coefficient of friction " μ ", is not permitted.

The specified tightening torques T_A must be complied with, applying DIN 25202 Screw-Connection Class "C", with an output-torque scatter of $\pm 5\%$.

3.4 Balancing after machining the finished bore

The balancing quality is to be specified in accordance with the specific application (however min. G16 to DIN ISO 1940).

Balancing prescription to DIN ISO 8821 of the shaft must be observed.



Balancing bores must not affect the load-bearing capacity of the coupling parts.

The balancing bores must be applied on a large radius with sufficient distance to the lands / pockets of the flexible elements, cams and the outer circumference.



In case of coupling part 1 the bottom of the pockets of the flexible elements must not be completely drilled through.

3.5 Installation of the coupling parts

Unscrew the set screw.

Clean holes and shaft ends.

Coat the bores of the coupling parts (1; 5) and the shafts with MoS₂ mounting paste (e.g. Microgleit LP 405).



Coupling parts (1; 5) with tapered bore and parallel-key connection must be fitted in cold condition and secured with suitable end plates, without drawing the coupling parts (1; 5) further onto the taper (fitting dimension = 0).

Place coupling parts (1; 5), with cylindrical bore heat up to max. + 150 °C, if necessary. When heating up observe the temperature range of the flexible elements (12) (see table 2 or 3), if necessary demount the flexible elements (12).



Heated coupling parts form an explosion hazard, therefore a non-explosive environment must be ensured.

Axial securing is effected by means of the set screw or end plate. When securing by set screw the shaft must not project or be set back from the inner sides of the hub.

Fit the set screw or end plate (tightening torques of the set screw to table 6).



**Failure to observe these instructions may result in breakage of the coupling.
Danger from flying fragments!
The coupling may then become an explosion hazard.**

If necessary, re-fit flexible elements (12). Observe the temperature range (see table 2 or 3).

The "Zero-side" of coupling part 6 is marked on the flange by a circular groove (0.2 mm deep). This side **must** be bolted to coupling part 5.

As a result of unfavourably adding the individual plain and concentricity deviations of coupling parts 5, 6 and 7 important concentricity deviations may occur, which can be reduced by changing the bolting position of coupling parts 5 and 6.

Align the coupling as described in item 3.6.

3.6 Possible misalignments

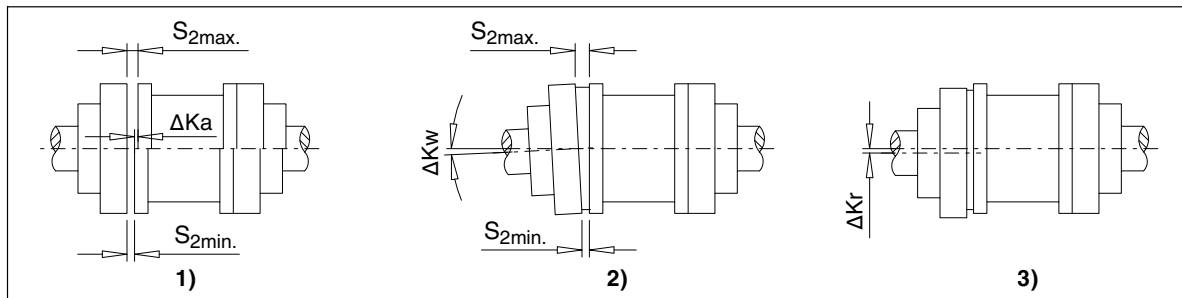

Fig. 5: Possible misalignments

- 1) Axial misalignment (ΔK_a)
- 2) Angular misalignment (ΔK_w)
- 3) Radial misalignment (ΔK_r)

3.6.1 Axial misalignment

The gap dimension ΔK_a should be set within the deviation permitted for the dimension "S2" (see section 1).

3.6.2 Angular misalignment

The angular misalignment ΔK_w can be measured as difference of the gap dimension ($\Delta S_2 = S_{2max.} - S_{2min.}$) $\Delta S_{2perm.}$, see table 7.

If required, the permissible angular misalignment ΔK_w can be calculated as follows:

$$\Delta K_{wperm.} \text{ in RAD} = \Delta S_{perm.} / DA \quad \Delta S_{perm.}, \text{ see table 7.}$$

$$\Delta K_{wperm.} \text{ in GRAD} = (\Delta S_{perm.} / DA) \times (180 / \pi) \quad \text{"DA" in mm see section 1.}$$

3.6.3 Radial misalignment

The permissible radial misalignment $\Delta K_{rperm.}$ can be found in table 7 (depending on the operating speed).

3.7 Alignment



When aligning the angular and radial misalignment should be kept as low as possible.

Misalignment values specified in table 7 are maximum permissible overall values in operation, resulting from mispositioning through imprecision during alignment and misalignment through operation (e.g. deformation through load, heat expansion).

Reduced misalignment in the coupling minimises expected wear on the flexible elements. Misalignment in the coupling gives rise to restorative forces which may impose inadmissible stress on adjacent machine parts (e.g. bearings).

3.8 Shaft-displacement values during operation



The following maximum permissible misalignments must by no means be exceeded during operation.
When aligning the angular and radial misalignment should be kept appreciably smaller (tending towards zero).

Table 7: Shaft-displacement values $\Delta S_{2\text{perm.}}$ and $\Delta K_{\text{perm.}}$, maximum permissible during operation, stated in mm (rounded)

Type, size		Coupling speed in 1/min								
H	HDS	250	500	750	1000	1500	2000	3000	4000	5000
80	88	0.4	0.3	0.25	0.2	0.2	0.15	0.15	0.1	0.1
95	103	0.5	0.35	0.25	0.25	0.2	0.2	0.15	0.1	0.1
110	118	0.5	0.35	0.3	0.25	0.2	0.2	0.15	0.1	0.1
125	135	0.5	0.4	0.3	0.25	0.25	0.2	0.15	0.15	0.1
140	152	0.6	0.4	0.35	0.3	0.25	0.2	0.2	0.15	
160	172	0.6	0.5	0.4	0.35	0.3	0.25	0.2	0.15	
180	194	0.6	0.5	0.4	0.35	0.3	0.25	0.2		
200	218	0.8	0.55	0.45	0.4	0.3	0.3	0.2		
225	245	0.8	0.55	0.5	0.4	0.35	0.3	0.25		
250	272	0.8	0.6	0.5	0.4	0.35	0.3			
280	305	1	0.7	0.6	0.5	0.4	0.35			
315	340	1	0.7	0.6	0.5	0.4	0.35			
350	380	1	0.8	0.6	0.6	0.5				
400	430	1.2	0.9	0.7	0.6	0.5				
440	472	1.3	1	0.7	0.7	0.6				

The numerical values of the table, as well as the intermediate values, can be calculated as follows:

$$\Delta K_{\text{perm.}} = \Delta S_{2\text{perm.}} = (0.1 + DA / 1000) \times 40 / \sqrt{n}$$

Coupling speed "n" in 1/min
"DA" in mm, see section 1.
Radial misalignment $\Delta K_{\text{perm.}}$ in mm

For speeds < 250 1/min the values in the colon "250 1/min" in table 7 apply.

3.9 Assignment of the tightening torques and wrench widths



The use of an impact screwdriver is not permissible!

Tightening torques apply to bolts with untreated surfaces which are not or only lightly oiled (coefficient of friction $\mu = 0.14$). The use of lubricant paint or lubricant, which affects the coefficient of friction " μ ", is not permitted.

The specified tightening torques T_A must be complied with, applying DIN 25202 Screw-Connection Class "C", with an output-torque scatter of $\pm 5\%$.

The tightening torques and wrench widths of the set screws are specified in table 6.

Table 8: Tightening torques for part 22

N-EUPEX coupling	N-EUPEX-DS coupling	Tightening torque T_A and wrench width SW for hexagon socket screws to DIN EN ISO 4762	
		T_A Nm	SW mm
80	88	13	5
95	103	13	5
110	118	14	6
125	135	17.5	6
140	152	29	8
160	172	35	8
180	194	44	8
200	218	67.5	10
225	245	86	10
250	272	145	14
280	305	185	14
315	340	200	14
350	380	260	17
400	430	340	17
440	472	410	17

4. Start-up and operation



Bolt-tightening torques for the coupling and tightening torques for the foundation bolts of the coupled machine must be checked before start-up. Enclosures (coupling protection, contact guard) must be fitted!
Overload conditions during start-up cannot be excluded. If the coupling breaks through overload, metal parts may fly off and cause personal injury and/or material damage.



If it is to be used below ground in potentially explosive areas, the coupling, which is made of cast iron or steel, must be provided with a robust casing to preclude the risk of ignition from e.g. friction, impact or friction sparks.
The depositing of heavy metal oxides (rust) on the coupling must be precluded by the casing or other suitable precautions.

The coupling must run with little noise and without vibration. Irregular behaviour must be treated as a fault requiring immediate remedy. In case of fault the drive must be stopped at once. The necessary measures for repair must be taken in accordance with the safety regulations applying.

5. Faults, causes and remedy

5.1 Possible cause of fault

Change in alignment:

- Rectify the cause of the change in alignment (e.g. loose foundation bolts).
- Align the coupling.
- Check the axial fastening and, if necessary, adjust.
- Wear check of the flexible elements (12) as described in section 6.

Flexible elements (12) worn:

- Wear check of the flexible elements (12) as described in section 6, if necessary replace flexible elements (12).

5.2 Incorrect use



**Failure to observe these instructions may result in breakage of the coupling.
Danger from flying fragments!
Through incorrect use the coupling may become an explosion hazard.**

5.2.1 Frequent faults when selecting the coupling and/or coupling size

- Important information for describing the drive and the environment are not communicated.
- System torque too high.
- System speed too high.
- Application factor not correctly selected.
- Chemically aggressive environment not taken into consideration.
- The ambient temperature is not permissible.
- Finished bore with inadmissible diameter and/or inadmissible assigned fits.
- Machining of parallel keyways of which the width across corners is greater than the width across corners of the parallel keyways to DIN 6885/1 with a maximum permissible bore.
- The transmission capacity of the shaft-to-hub connection is not appropriate to the operating conditions.
- Maximum load or overload conditions are not being taken into consideration.
- Dynamic load conditions are not being taken into consideration.
- Shaft-to-hub connection resulting in impermissible material stress on the coupling.
- Operating conditions are being changed without authorisation.
- Coupling and machine / drive train form a critical torsional, axial and bending vibration system.
- Fatigue torque load too high.

5.2.2 Frequent faults when fitting the coupling

- Components with transport or other damage are being fitted.
- When fitting coupling parts in a heated condition, already fitted N-EUPEX flexible elements (12) are being excessively heated.
- The shaft diameter is beyond the specified tolerance range.
- Coupling parts are being interchanged, i.e. their assignment to the specified shaft is incorrect.

- Specified axial fastenings are not fitted.
- Specified tightening torques are not being adhered to.
- Bolts are inserted dry or greased.
- Flange surfaces of screwed connections have not been cleaned.
- Alignment and/or shaft-misalignment values do not match the specifications in the instructions manual.
- The coupled machines are not correctly fastened to the foundation, and as a result shifting of the machines e.g. through loosening of the foundation-screw connection is causing excessive displacement of the coupling parts.
- The coupled machines are not sufficiently earthed.
- N-EUPEX flexible elements (12) are not fitted.
- The coupling guard used is not suitable.

5.2.3 Frequent faults in maintenance

- Maintenance intervals are not being adhered to.
- Original N-EUPEX spare parts are not being used.
- Old or damaged N-EUPEX spare parts are being used.
- Different N-EUPEX flexible elements (12) are being used.
- Leakage in the vicinity of the coupling is not being identified and as a result chemically aggressive media are damaging the coupling.
- Fault indications (noise, vibration, etc.) are not being observed.
- Specified tightening torques are not being adhered to.
- Alignment and/or shaft-misalignment values do not match the specifications in the instructions manual.

6. Maintenance and repair

6.1 Maintenance interval



On Type H the torsional backlash between the two coupling parts must be checked after three months, then at least once a year.

On type HDS the torsional backlash of the flexible elements (12) need be checked against Directive 94/9/EC only if a failure of the flexible elements (12) and as a result a stoppage of the drive result in an explosion hazard. It is recommended that preventive maintenance, also on coupling types HDS, include the regular check of the torsional backlash.

The flexible elements (12) must be replaced, when the torsional backlash exceeds the value stated in table 9.

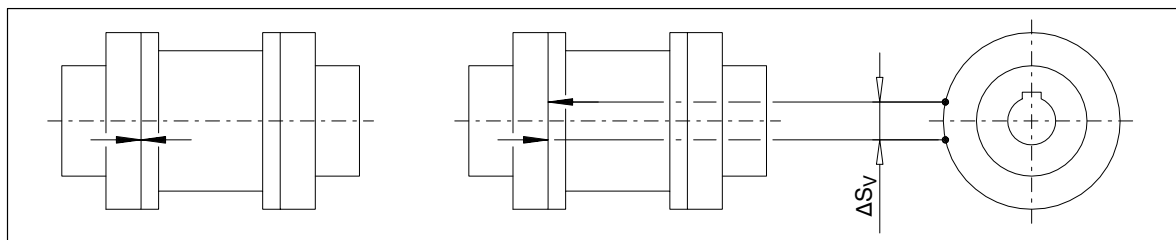

Fig. 6: Wear mark

Table 9: Wear mark for the torsional backlash of type H

Size	80	95	110	125	140	160	180	200	225	250	280	315	350	400	440
Wear mark ΔS_V (mm)	5.0	6.0	7.0	8.0	8.0	8.0	8.0	8.5	9.0	10.0	11.5	10.5	11.5	13.0	14.0

Table 10: Wear mark for the torsional backlash of type HDS

Size	88	103	118	135	152	172	194	218	245	272	305	340	380	430	472
Wear mark ΔS_V (mm)	5.0	7.0	9.0	10.5	11.5	9.0	8.0	7.0	6.5	7.0	8.0	6.5	7.0	10.0	12.0



If the above specified maintenance instructions are not adhered to, a correct operation within the meaning of the explosion-prevention requirements and/or Directive 94/9/EC can no longer be guaranteed on type H (types with form fitting of the metal parts). Use in potentially explosive areas is then not permitted.



Failure to observe these instructions may result in breakage of the coupling. Danger from flying fragments!

6.2 Replacement of wearing parts

The flexible elements (12) can be replaced without moving the coupled machines.

Hold and/or brace coupling part 6. Undo the screw connection (22) of coupling part 5 / 6 and coupling part 6 / 7. Using the forcing-off threads in coupling part 6, force coupling parts 5 and 7 out of the centring holes. Push coupling part 7 as far as possible into coupling part 1. Demount coupling part 6 radially. Draw coupling part 7 from coupling part 1. The flexible elements (12) are now freely accessible.

The flexible elements (12) must be replaced in sets. Only identical flexible elements (12) may be used.

For re-assembly, the instructions in sections 3 and 4 must be observed.

6.3 Demounting the coupling parts in case of shaft-hub connection with parallel key

Hold and/or brace coupling part 6. Undo the screw connection (22) of coupling part 5 / 6 and coupling part 6 / 7. Using the forcing-off threads in coupling part 6, force coupling parts 5 and 7 out of the centring holes. Push coupling part 7 as far as possible into coupling part 1. Demount coupling part 6 radially. Draw coupling part 7 from part 1.

Remove the axial fastening (set screw, end plate). Mount suitable detaching device. Using a burner, heat coupling part (1; 5) along its length and above the parallel keyway (max. + 80 °C). When heating up observe the temperature range of the flexible elements (12) (see tables 2 and 3), if necessary demount the flexible elements (12).



Burner and heated coupling parts form an explosion hazard; therefore a non-explosive environment must be ensured.

Pull the coupling part off. Examine the hub bore and the shaft for damage, and protect against rust. Damaged parts must be replaced.

For re-assembly, the instructions in sections 3 and 4 must be observed.

7. Stocking spare parts

7.1 Spare parts

For ordering spare parts state the following data, as far as possible:

- Our order number and position
- Drawing number
- Coupling type and coupling size
- Part number (see spare-parts list)
- Bore, bore tolerance, keyway and balancing as well as particular characteristics such as flange-connection dimensions, intermediate-shaft length, brake-drum dimensions
- Any special details such as temperature, electrically insulating

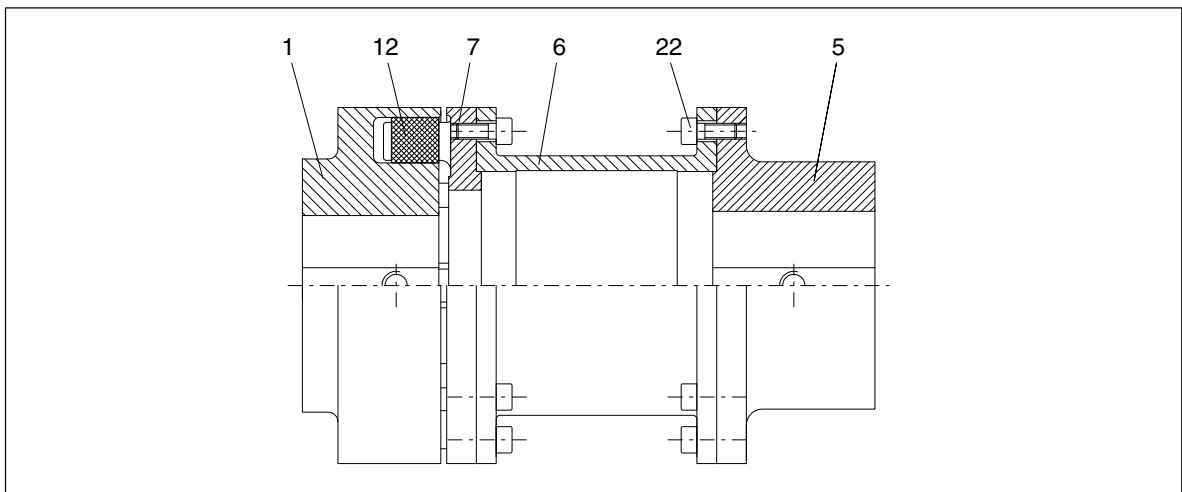

Fig. 7: Spare-parts drawing

Table 11: Table 11: Spare-parts list

Type H, HDS	
Part number	Designation
1	Coupling part 1
5	Coupling part 5
6	Coupling part 6
7	Coupling part 7
12	Flexible element
22	Cheese-head bolt

8. Declarations

8.1 EC declaration of conformity



EC declaration of conformity

within the meaning of EC Directive 94/9/EC of 23.03.1994 and the legal requirements laid down for its implementation

The manufacturer, Siemens AG, 46395 Bocholt, Germany, declares that the equipment described in these operating instructions:

**FLENDER N-EUPEX® and
FLENDER N-EUPEX-DS®
couplings
Types H and
HDS**

is in conformity with Article 1 and Article 8, Paragraph 1 b) ii) of Directive 94/9/EC and complies with the requirements of Directive 94/9/EC and the following standards:

DIN EN 1127-1 : 02-2008
DIN EN 13463-1 : 07-2009

The technical documentation has been delivered to the body named below:

DEKRA EXAM GmbH, D - 44727 Bochum, code number: 0158.

Bocholt, 2011-09-06



Andre Jansen
(Director Engineering KUE)

Bocholt, 2011-09-06

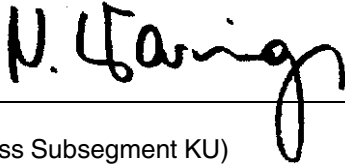

Nicola Warning
(Director Business Subsegment KU)

Further Information:

"FLENDER gear units" on the Internet

www.siemens.com/gearunits

"FLENDER couplings" on the Internet

www.siemens.com/couplings

Service & Support:

<http://support.automation.siemens.com/WW/view/en/10803928/133300>

Lubricants:

<http://support.automation.siemens.com/WW/view/en/42961591/133000>

Siemens AG
Industry Sector
Mechanical Drives
Alfred-Flender-Straße 77
46395 Bocholt
GERMANY

Subject to modifications

© Siemens AG 2011

www.siemens.com/drive-technologies